



# HP 2310t and 2310ti LCD Touch Monitors

User Guide

© 2010 Hewlett-Packard Development  
Company, L.P.

Microsoft, Windows, and Windows Vista are either trademarks or registered trademarks of Microsoft Corporation in the United States and/or other countries.

The only warranties for HP products and services are set forth in the express warranty statements accompanying such products and services. Nothing herein should be construed as constituting an additional warranty. HP shall not be liable for technical or editorial errors or omissions contained herein.

This document contains proprietary information that is protected by copyright. No part of this document may be photocopied, reproduced, or translated to another language without the prior written consent of Hewlett-Packard Company.

First Edition (March 2010)

Document Part Number: 603455-001

## About This Guide

This guide provides information on setting up the monitor, installing drivers, using the on-screen display menu, troubleshooting and technical specifications.

- 
- ⚠ **WARNING!** Text set off in this manner indicates that failure to follow directions could result in bodily harm or loss of life.
  - ⚠ **CAUTION:** Text set off in this manner indicates that failure to follow directions could result in damage to equipment or loss of information.
  - 📄 **NOTE:** Text set off in this manner provides important supplemental information.
-



---

# Table of contents

<b>1 Product Features</b> .....	<b>1</b>
HP 2310t and 2310ti Models .....	1
<b>2 Safety and Maintenance Guidelines</b> .....	<b>2</b>
Important Safety Information .....	2
Maintenance Guidelines .....	2
Cleaning the Monitor .....	3
Shipping the Monitor .....	3
<b>3 Setting Up the Monitor</b> .....	<b>4</b>
Rear Components .....	4
HP 2310t Model .....	4
HP 2310ti Model .....	5
Routing the Cables .....	6
Connecting the Cables .....	6
Connecting the VGA (Analog) Video Cable (HP 2310ti Model Only) .....	6
Connecting the DVI-D (Digital) Video Cable .....	7
Connecting the HDMI (Digital) Video Cable (HP 2310t Model Only) .....	7
Connecting the Audio Cable .....	8
Connecting the USB Cable .....	8
Connecting the Power Cord .....	9
Adjusting the Tilt .....	9
Keyboard Parking .....	11
Turning on the Monitor .....	11
Removing the Monitor Pedestal Base .....	12
Mounting the Monitor .....	14
Locating the Rating Labels .....	15
Installing a Cable Lock .....	15
<b>4 Operating the Monitor</b> .....	<b>16</b>
Software and Utilities .....	16
The Information File .....	16
The Image Color Matching File .....	16
Installing the .INF and .ICM Files .....	17
Installing from the CD .....	17
Downloading from the Internet .....	17
Installing the Touch Driver (for Windows XP only) .....	17

Using the Touch Screen .....	17
Using the Auto-Adjustment Function .....	19
Front Panel Controls .....	20
Adjusting the Monitor Settings .....	21
Using the On-Screen Display Menu .....	21
OSD Menu Selections .....	22
Optimizing Digital Conversion .....	26
Identifying Monitor Conditions .....	27
Sleep Timer Mode .....	28
sRGB Support .....	29
Changing the Color Temperature .....	29
Installing the sRGB ICM File for Microsoft Windows 2000 and Windows XP .....	29
Installing the sRGB ICM File for Microsoft Windows Vista .....	29
Installing the sRGB ICM File for Microsoft Windows 7 .....	30
<b>Appendix A Troubleshooting .....</b>	<b>31</b>
Solving Common Problems .....	31
Online Technical Support .....	33
Preparing to Call Technical Support .....	33
<b>Appendix B Technical Specifications .....</b>	<b>34</b>
2310t and 2310ti Models .....	34
Recognizing Preset Display Resolutions .....	35
2310t and 2310ti Factory Preset Display Modes .....	35
2310t High Definition Video Formats .....	35
Entering User Modes .....	36
Energy Saver Feature .....	36
<b>Appendix C Agency Regulatory Notices .....</b>	<b>37</b>
Federal Communications Commission Notice .....	37
Modifications .....	37
Cables .....	37
Declaration of Conformity for Products Marked with the FCC Logo (United States Only) .....	37
Canadian Notice .....	38
Avis Canadien .....	38
European Union Regulatory Notice .....	38
German Ergonomics Notice .....	39
Japanese Notice .....	39
Korean Notice .....	39
Power Cord Set Requirements .....	39
Japanese Power Cord Requirements .....	39
Product Environmental Notices .....	40
Materials Disposal .....	40

Disposal of Waste Equipment by Users in Private Household in the European Union ..... 40  
HP Recycling Program ..... 40  
Chemical Substances ..... 40  
Restriction of Hazardous Substances (RoHS) ..... 40  
Turkey EEE Regulation ..... 41

**Appendix D LCD Monitor Quality and Pixel Policy ..... 42**





---

# 1 Product Features

## HP 2310t and 2310ti Models

The HP LCD touch screen monitors have a wide aspect active matrix thin-film transistor (TFT) panel. The monitors feature:

- 58.42 cm (23-inch) diagonal viewable area display with 1920 x 1080 resolution, plus full-screen support for lower resolutions
- Wide viewing angle to allow viewing from a sitting or standing position, or moving side-to-side
- 55 degree tilt capability for use while in a standing position
- Removable pedestal and Video Electronics Standards Association (VESA) standard mounting holes for flexible mounting solutions, including wall-mounting
- 2310t supports DVI digital and HDMI digital signals with DVI-D signal cable provided
- 2310ti supports VGA analog and DVI digital signals with DVI-D signal cable provided
- USB cable included to connect the monitor to a USB connector on a computer allowing for touch screen capability
- Plug and play capability if supported by the computer system
- Fast response time, providing better experience for gaming and graphics
- Security slot provision on rear of monitor for optional cable lock
- Cable management feature for placement of cables and cords
- On-Screen Display (OSD) adjustments in several languages for ease of setup and screen optimization
- Built-in stereo speakers, downward firing, with audio cable included
- Keyboard parking
- Quick View settings display
- HDCP (High-Bandwidth Digital Content Protection) copy protection on DVI and HDMI inputs
- Software and documentation CD that includes monitor drivers and product documentation
- Energy saver feature to meet requirements for reduced power consumption
- Compliant with the following regulated specifications:
  - European Union CE Directives
  - Swedish MPR II 1990

---

## 2 Safety and Maintenance Guidelines

### Important Safety Information

A power cord is included with the monitor. If another cord is used, use only a power source and connection appropriate for this monitor. For information on the correct power cord set to use with the monitor, refer to [Power Cord Set Requirements on page 39](#).

---

⚠ **WARNING!** To reduce the risk of electric shock or damage to the equipment:

- Do not disable the power cord grounding feature. The grounding plug is an important safety feature.
- Plug the power cord in a grounded (earthed) outlet that is easily accessible at all times.
- Disconnect power from the product by unplugging the power cord from the electrical outlet.

For your safety, do not place anything on power cords or cables. Arrange them so that no one may accidentally step on or trip over them. Do not pull on a cord or cable. When unplugging from the electrical outlet, grasp the cord by the plug.

To reduce the risk of serious injury, read the *Safety and Comfort Guide*. It describes proper workstation, setup, posture, and health and work habits for computer users, and provides important electrical and mechanical safety information. This guide is located on the Web at <http://www.hp.com/ergo> and/or on the documentation CD, if one is included with the monitor.

⚠ **CAUTION:** For the protection of the monitor, as well as the computer, connect all power cords for the computer and its peripheral devices (such as a monitor, printer, scanner) to some form of surge protection device such as a power strip or Uninterruptible Power Supply (UPS). Not all power strips provide surge protection; the power strips must be specifically labeled as having this ability. Use a power strip whose manufacturer offers a Damage Replacement Policy so you can replace the equipment, if surge protection fails.

---

Use the appropriate and correctly sized furniture designed to properly support your HP LCD monitor.

⚠ **WARNING!** LCD monitors that are inappropriately situated on dressers, bookcases, shelves, desks, speakers, chests, or carts may fall over and cause personal injury.

Care should be taken to route all cords and cables connected to the LCD monitor so that they can not be pulled, grabbed, or tripped over.

---

### Maintenance Guidelines

To enhance the performance and extend the life of the monitor:

- Do not open the monitor cabinet or attempt to service this product yourself. Adjust only those controls that are covered in the operating instructions. If the monitor is not operating properly or has been dropped or damaged, contact an authorized HP dealer, reseller, or service provider.
- Use only a power source and connection appropriate for this monitor, as indicated on the label/back plate of the monitor.
- Be sure the total ampere rating of the products connected to the outlet does not exceed the current rating of the electrical outlet, and the total ampere rating of the products connected to the

cord does not exceed the rating of the cord. Look on the power label to determine the ampere rating (AMPS or A) for each device.

- Install the monitor near an outlet that you can easily reach. Disconnect the monitor by grasping the plug firmly and pulling it from the outlet. Never disconnect the monitor by pulling the cord.
- Turn the monitor off when not in use. You can substantially increase the life expectancy of the monitor by using a screen saver program and turning off the monitor when not in use.

---

 **NOTE:** Monitors with a “burned-in image” are not covered under the HP warranty.

---

- Slots and openings in the cabinet are provided for ventilation. These openings must not be blocked or covered. Never push objects of any kind into cabinet slots or other openings.
- Do not drop the monitor or place it on an unstable surface.
- Do not allow anything to rest on the power cord. Do not walk on the cord.
- Keep the monitor in a well-ventilated area, away from excessive light, heat or moisture.
- When removing the monitor base, you must lay the monitor face down on a soft area to prevent it from getting scratched, defaced, or broken.

## Cleaning the Monitor

1. Turn off the monitor and unplug the power cord from the back of the unit.
2. Dust the monitor by wiping the screen and the cabinet with a soft, clean antistatic cloth.
3. For more difficult cleaning situations, use a 50/50 mix of water and Isopropyl alcohol.

---

△ **CAUTION:** Spray the cleaner onto a cloth and use the damp cloth to gently wipe the screen surface. Never spray the cleaner directly on the screen surface. It may run behind the bezel and damage the electronics.

**CAUTION:** Do not use cleaners that contain any petroleum based materials such as benzene, thinner, or any volatile substance to clean the monitor screen or cabinet. These chemicals may damage the monitor.

---

## Shipping the Monitor

Keep the original packing box in a storage area. You may need it later if you move or ship the monitor.

# 3 Setting Up the Monitor

To set up the monitor, ensure that the power is turned off to the monitor, computer system, and other attached devices, then follow the instructions below.

## Rear Components

### HP 2310t Model

Figure 3-1 2310t Rear Components

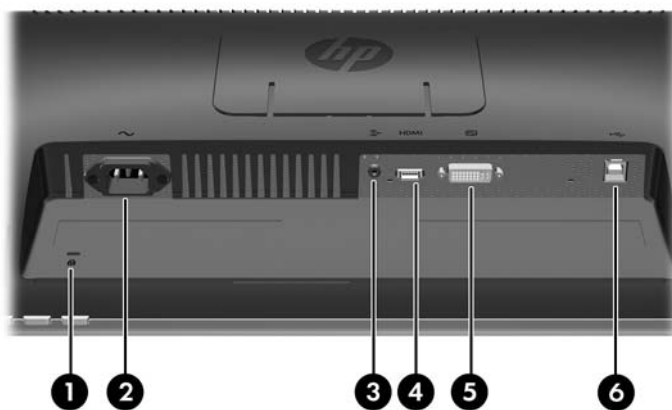

Table 3-1 2310t Rear Components

Component	Function
1 Cable Lock Provision	Provides slot for use with cable security locks.
2 AC Power Connector	Connects the AC power cord to the monitor.
3 Audio Connector	Connects the audio cable to the monitor.
4 HDMI Connector	Connects the HDMI cable to the monitor.
5 DVI-D Connector	Connects the DVI-D cable to the monitor.
6 USB Upstream Connector	Connects the monitor USB cable to a host computer for touch screen support.

## HP 2310ti Model

Figure 3-2 2310ti Rear Components

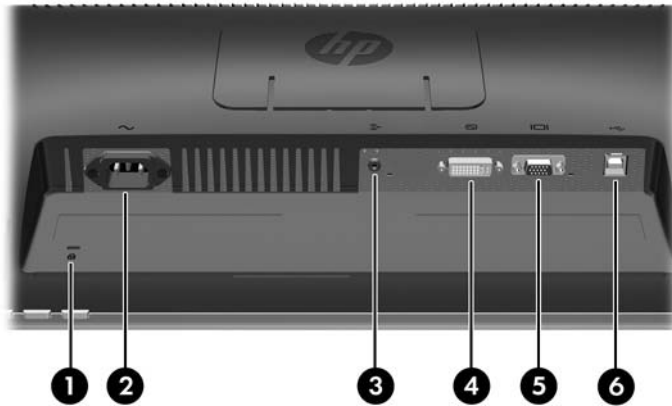

Table 3-2 2310ti Rear Components

Component	Function
1 Cable Lock Provision	Provides slot for use with cable security locks.
2 AC Power Connector	Connects the AC power cord to the monitor.
3 Audio Connector	Connects the audio cable to the monitor.
4 DVI-D Connector	Connects the DVI-D cable to the monitor.
5 VGA Connector	Connects the VGA cable to the monitor.
6 USB Upstream Connector	Connects the monitor USB cable to a host computer for touch screen support.

## Routing the Cables

Before connecting the cables, route them through the cable routing hole in the center of the stand.

**Figure 3-3** Routing Cables

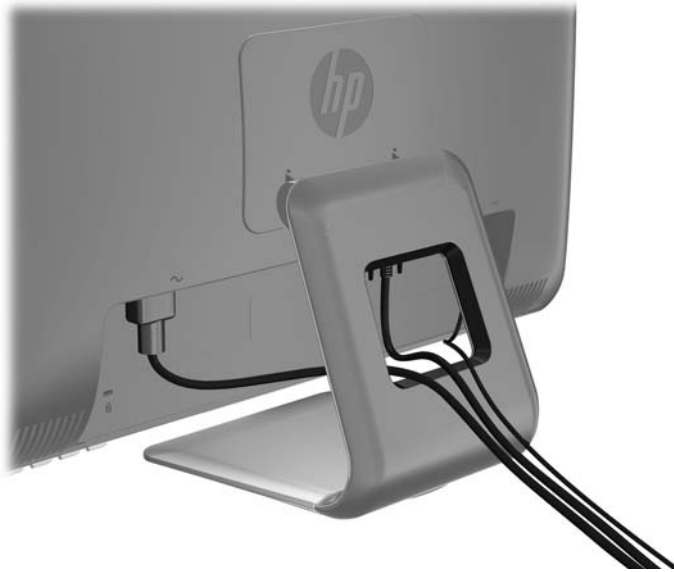

## Connecting the Cables

△ **CAUTION:** Before connecting cables to the monitor, ensure that the computer and the monitor are powered off.

### Connecting the VGA (Analog) Video Cable (HP 2310ti Model Only)

For analog operation, connect one end of a VGA signal cable (sold separately) to the VGA connector on the rear of the monitor and the other end to the VGA connector on the computer.

**Figure 3-4** Connecting the VGA Cable

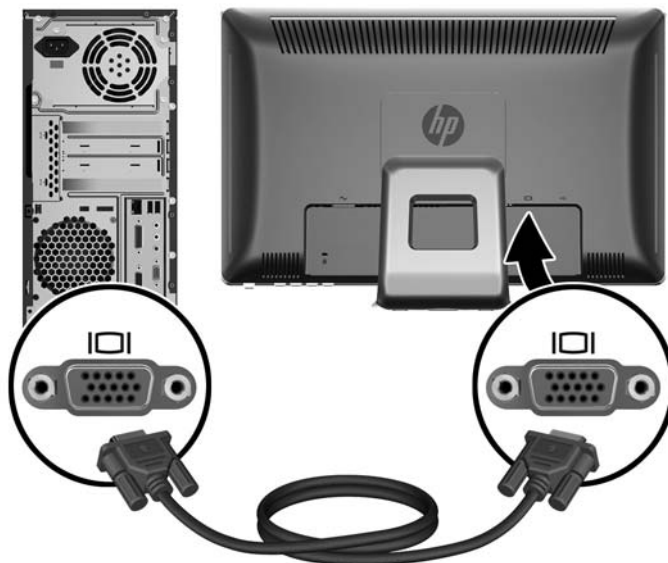

## Connecting the DVI-D (Digital) Video Cable

For DVI digital operation, connect one end of the provided DVI-D signal cable to the DVI connector on the rear of the monitor and the other end to the DVI connector on the computer.

**Figure 3-5** Connecting the DVI-D Cable

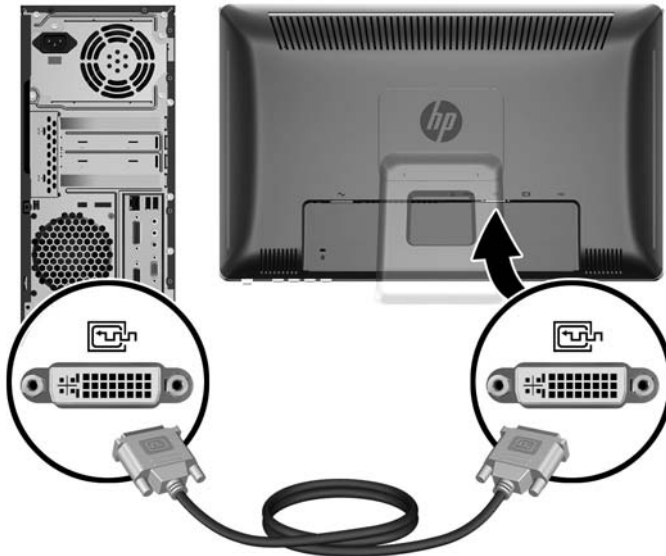

## Connecting the HDMI (Digital) Video Cable (HP 2310t Model Only)

For HDMI digital operation, connect one end of an HDMI signal cable (sold separately) to the rear of the monitor and the other end to a computer or other device with an HDMI connector.

**NOTE:** The HDMI cable supports digital audio and video signals. You do not need to connect a separate audio cable when using an HDMI cable.

**Figure 3-6** Connecting the HDMI Cable

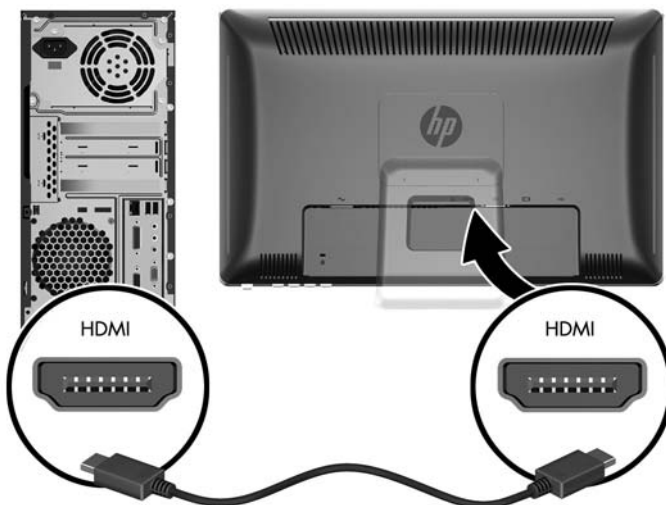

## Connecting the Audio Cable

Connect one end of the provided audio cable to the Audio In connector on the rear of the monitor and the other end to the Audio Out connector on the computer.

 **NOTE:** If you connect an HDMI cable (2310t model only) between the monitor and computer, you do not need to connect the audio cable. The HDMI cable supports audio and video digital signals.

**Figure 3-7** Connecting the Audio Cable

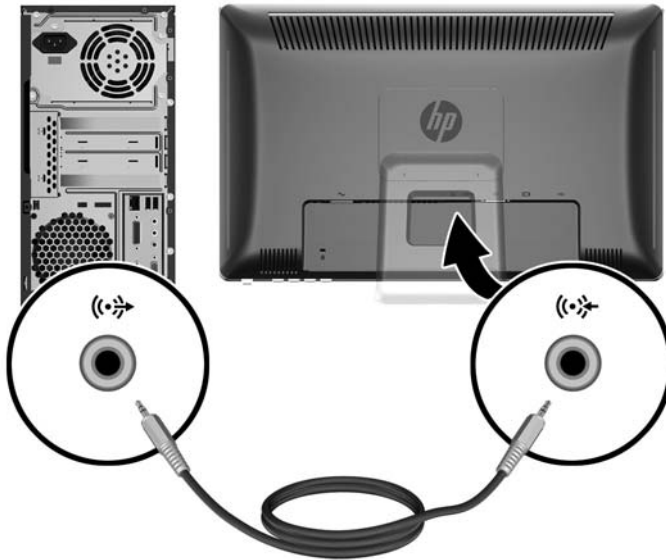

## Connecting the USB Cable

Connect one end of the provided USB cable to the USB upstream connector on the rear of the monitor and the other end to a USB downstream connector on the computer.

 **NOTE:** You must connect the USB cable for touch screen functionality.

**Figure 3-8** Connecting the USB Cable

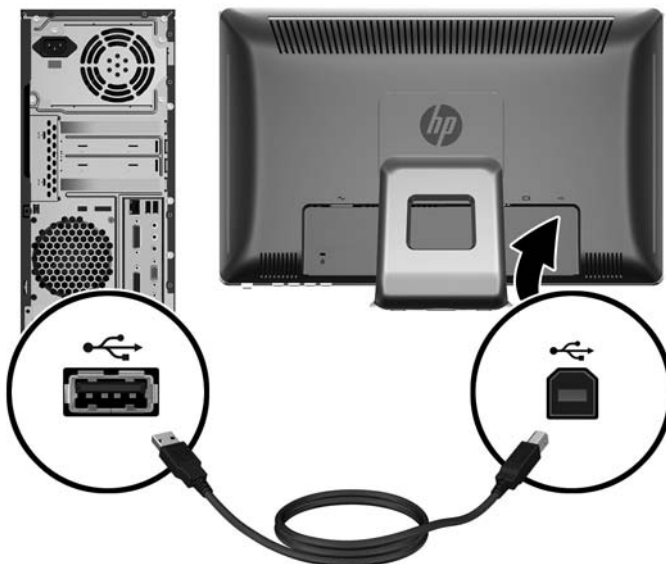



## Connecting the Power Cord

Connect one end of the power cord to the AC power connector on the rear of the monitor, and the other end to an electrical wall outlet.

**Figure 3-9** Connecting the Power Cord

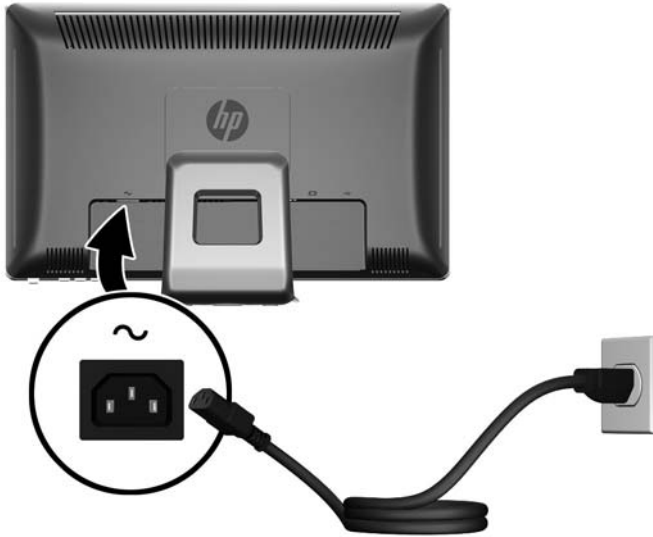

---

**⚠ WARNING!** To reduce the risk of electric shock or damage to the equipment:

Do not disable the power cord grounding plug. The grounding plug is an important safety feature.

Plug the power cord into a grounded (earthed) electrical outlet that is easily accessible at all times.

Disconnect power from the equipment by unplugging the power cord from the electrical outlet.

For your safety, do not place anything on power cords or cables. Arrange them so that no one may accidentally step on or trip over them. Do not pull on a cord or cable. When unplugging from the electrical outlet, grasp the cord by the plug.

---

## Adjusting the Tilt

For optimal viewing, adjust the screen tilt to your own preference, as follows:

1. Face the front of the monitor and hold the base so that you do not topple the monitor while changing the tilt.

2. Adjust the tilt by moving the top edge of the monitor either toward or away from you, without touching the screen. The monitor will tilt forward 5 degrees and back 55 degrees.

**Figure 3-10** Adjusting the Tilt



# Keyboard Parking

If you need more space on your desktop, place the keyboard under the monitor when not in use.

**Figure 3-11** Keyboard Parking



## Turning on the Monitor

1. Press the power button on the computer to turn it on.
2. Press the power button on the front of the monitor to turn it on.

△ **CAUTION:** Burn-in image damage may occur on monitors that display the same static image on screen for a prolonged period of time.\* To avoid burn-in image damage on the monitor screen, you should always activate a screen saver application or turn off the monitor when it is not in use for a prolonged period of time. Image retention is a condition that may occur on all LCD screens. Monitors with a “burned-in image” are not covered under the HP warranty.

\* A prolonged period of time is 12 consecutive hours of non-use.

📄 **NOTE:** If pressing the power button has no effect, the Power Button Lockout feature may be enabled. To disable this feature, press and hold the monitor power button for 10 seconds.

**NOTE:** You can disable the power LED in the OSD menu. Press the Menu button on the front of the monitor, then select **Management > Bezel Power LED > Off**.

When the monitor is powered on, a Monitor Status message is displayed for five seconds. The message shows which input is the current active signal, the status of the auto-switch source setting (On or Off), the default source signal, the current preset display resolution, and the recommended preset display resolution.

The monitor automatically scans the signal inputs for an active input and uses that input for the display. If two inputs are active, the monitor will display the default input source. If the default source is not an active input, then the monitor will display the other input if it is active. You can change the default source in the OSD by pressing the front panel Menu button and selecting **Source Control > Default Source**.

## Removing the Monitor Pedestal Base

You can remove the monitor panel from the pedestal base to mount the panel on a wall, a swing arm, or other mounting fixture (purchased separately).

△ **CAUTION:** Before beginning to disassemble the monitor, be sure the monitor is turned off and the power and signal cables are both disconnected. Also disconnect the USB and audio cables if they are connected to the monitor.

1. Disconnect and remove all cables from the back of the monitor.
2. Lay the monitor face down on a flat surface covered by a dry, clean cloth.
3. Pry back the top of the VESA cover plate (1) then slide it up (2) to remove it from the back of the monitor.

**Figure 3-12** Removing the VESA Cover Plate



4. Remove the two screws that secure the pedestal base to the monitor panel.

**Figure 3-13** Removing the Pedestal Base Screws

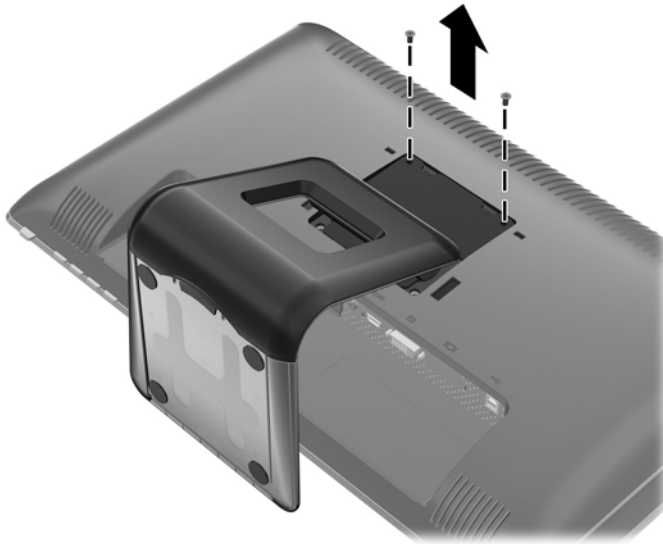

5. Tilt the top of the pedestal base mount back (1) then slide it up and lift it off the LCD panel (2).

**Figure 3-14** Removing the Pedestal Base

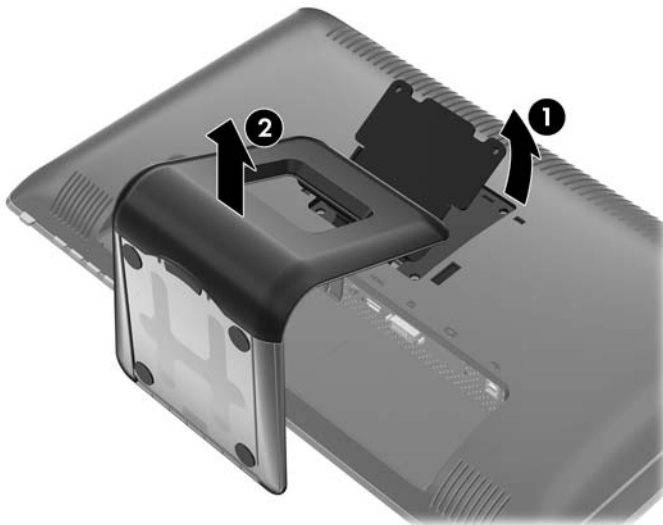

## Mounting the Monitor

 **NOTE:** This apparatus is intended to be supported by UL or CSA Listed wall mount bracket.

1. Remove the monitor panel from the pedestal base. Refer to [Removing the Monitor Pedestal Base on page 12](#) in the previous section.
2. To attach the monitor to a swing arm, insert four 10mm screws through the holes on the swing arm plate and into the mounting holes on the monitor.

△ **CAUTION:** This monitor supports the VESA industry standard 100 mm mounting holes. To attach a third-party mounting solution to the monitor, four 4 mm, 0.7 pitch, and 10 mm long screws are required (not provided with the monitor). Longer screws must not be used because they may damage the monitor. It is important to verify that the manufacturer's mounting solution is compliant with the VESA standard and is rated to support the weight of the monitor display panel. For best performance, it is important to use the power and video cables provided with the monitor.

**Figure 3-15** Installing the Monitor on a Swing Arm

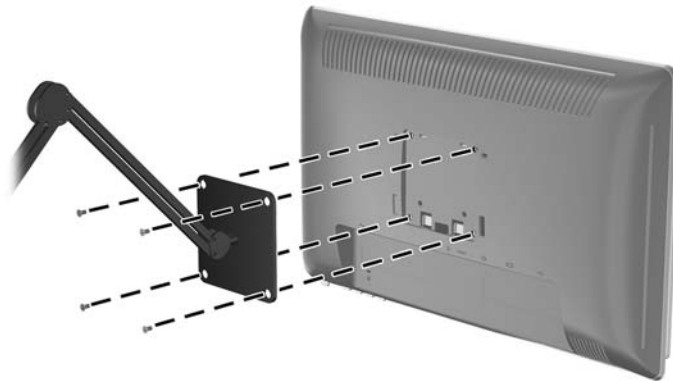

To attach the monitor to other mounting fixtures, follow the instructions included with the mounting fixture to ensure that the monitor is safely attached.

3. Reconnect the cables to the monitor panel.

## Locating the Rating Labels

The rating labels on the monitor provide the spare part number, product number, and serial number. You may need these numbers when contacting HP about the monitor model. The rating labels are located on the rear panel of the monitor display head.

**Figure 3-16** Locating the Rating Labels

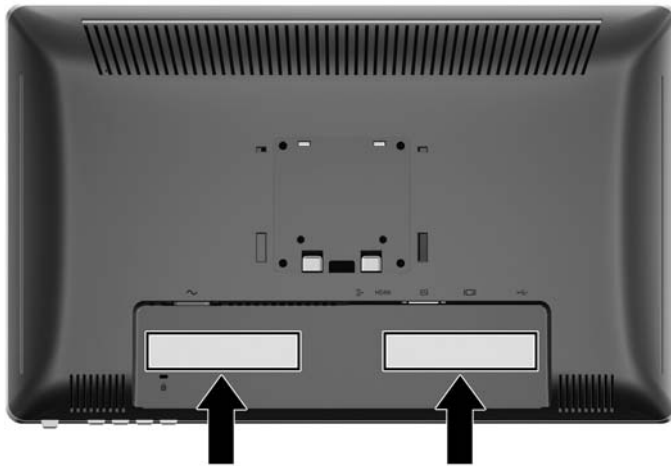

## Installing a Cable Lock

You can secure the monitor to a fixed object with an optional cable lock available from HP.

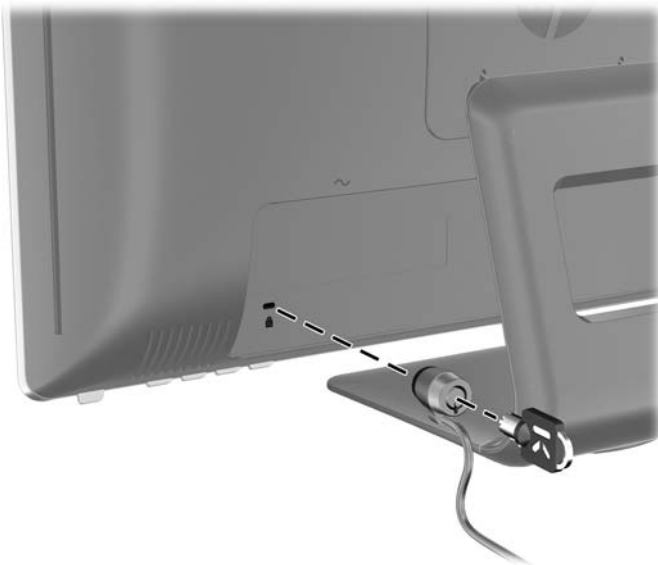

---

# 4 Operating the Monitor

## Software and Utilities

The CD that comes with the monitor contains files you can install on the computer:

- an .INF (Information) file
- an .ICM (Image Color Matching) file
- Touch driver (for Windows XP only)
- auto-adjustment pattern utility
- additional software for the monitor model

---

 **NOTE:** If the monitor does not include a CD, the .INF and .ICM files can be downloaded from the HP monitors support Web site. See [Downloading from the Internet on page 17](#) in this chapter.

---

### The Information File

The .INF file defines monitor resources used by Microsoft Windows operating systems to ensure monitor compatibility with the computer's graphics adapter.

This monitor is Microsoft Windows Plug and Play compatible and the monitor will work correctly without installing the .INF file. Monitor Plug and Play compatibility requires that the computer's graphic card is VESA DDC2-compliant and that the monitor connects directly to the graphics card. Plug and Play does not work through separate BNC type connectors or through distribution buffers/boxes.

### The Image Color Matching File

The .ICM files are data files that are used in conjunction with graphics programs to provide consistent color matching from monitor screen to printer, or from scanner to monitor screen. This file is activated from within graphics programs that support this feature.

---

 **NOTE:** The ICM color profile is written in accordance with the International Color Consortium (ICC) Profile Format specification.

---



# Installing the .INF and .ICM Files

After you determine that you need to update, you can install the .INF and .ICM files from the CD or download them.

## Installing from the CD

To install the .INF and .ICM files on the computer from the CD:

1. Insert the CD in the computer CD-ROM drive. The CD menu is displayed.
2. View the **Monitor Driver Software Readme** file.
3. Select **Install Monitor Driver Software**.
4. Follow the on-screen instructions.
5. Ensure that the proper resolution and refresh rates appear in the Windows Display control panel.

---

 **NOTE:** You may need to install the digitally signed monitor .INF and .ICM files manually from the CD in the event of an installation error. Refer to the Monitor Driver Software Readme file on the CD.

---

## Downloading from the Internet

To download the latest version of .INF and .ICM files from the HP monitors support Web site:

1. Refer to <http://www.hp.com/support> and select the country region.
2. Follow the links for the monitor to the support page and download page.
3. Ensure the system meets the requirements.
4. Download the software by following the instructions.

## Installing the Touch Driver (for Windows XP only)

The touch driver is only needed for systems that use the Microsoft Windows XP operating system. You do not need to install the touch driver if your system has Windows Vista or Windows 7.

To install the touch driver:

1. Insert the CD in the computer CD-ROM drive. The CD menu is displayed (or open Windows Explorer and run the Touch\_Driver\_Setup.exe from the CD).
2. Click **install Touch Driver for Microsoft Windows XP** from the CD menu. The Touch Driver Setup Wizard will be displayed.

---

 **NOTE:** Touch drivers are not required for systems running Microsoft Windows Vista or Windows 7 operating systems.

---

3. Follow the on-screen instructions in the wizard to install the driver.

---

 **NOTE:** Touch gesture functionality varies among Windows operating systems. Refer to [Using the Touch Screen on page 17](#) for more information.

---

## Using the Touch Screen

Before using the touch function, make sure the USB cable is connected, the touch driver from the CD is installed (if you are running Windows XP), and the Windows operating system is started.

 **NOTE:** When the touch function is active, make sure there are no foreign objects blocking the left, right, or bottom edges of the monitor LCD panel.

The touch function may replace the mouse after you start the Windows operating system and introduce appropriate gesture judgement. Gesture judgement and related Windows software applications are listed below:

 **NOTE:** The finger operations below may not work with some software applications.

If your computer goes into sleep mode, touching the touch screen will NOT awaken the computer from sleep mode.

**Table 4-1 Touch Screen Operation**

Finger Operation	Windows 7 Support (touch driver not required)	Windows Vista Support (touch driver not required)	Windows XP Support (touch driver required)
<b>Tap and Double-tap</b> – Touch and release to click. This is the most basic touch action. You can also double-tap to open files and folders.	Yes	Yes	Yes
<b>Drag</b> – Touch and slide your finger on screen. Like dragging with a mouse, this moves icons around the desktop, moves windows, selects text (by dragging left or right), etc.	Yes	Yes	Yes
<b>Scroll</b> – Drag up or down on the content (not the scroll bar!) of a scrollable window to scroll. You can toss the page with more finger inertia and there is a little bounce when the end of the page is reached. Scrolling is available with one or more fingers.	Yes (limited)	Yes (limited)	No
<b>Zoom</b> – Pinch two fingers together or spread them apart to zoom in or out on a document. This works in applications that support mouse wheel zooming.	Yes	No	No
<b>Two-Finger Tap</b> – Tapping with two fingers simultaneously zooms in about the center of the gesture or restores to the default zoom.	Yes (limited)	No	No
<b>Rotate</b> – Touch two spots on a digital photo and twist to rotate it just like a real photo.	Yes	No	No
<b>Flicks</b> – Flick left or right to navigate back and forward in a browser and other applications.	Yes	Yes	No
<b>Press-and-hold</b> – Hold your finger on screen for a moment and release after the animation to get a right-click.	Yes	Yes	No
<b>Press-and-tap with a second finger</b> – To get right-click, just like you would click the right button on a mouse or track pad.	Yes	No	No

 **NOTE:** You can use your finger or a stylus (not provided) for touch applications.

# Using the Auto-Adjustment Function

You can optimize the screen performance for the VGA (analog) input by using the [Auto/OK](#) button on the monitor and the auto-adjustment pattern software utility on the CD provided.

Do not use this procedure if the monitor is using a DVI or HDMI input. If the monitor is using a VGA (analog) input, this procedure can correct the following image quality conditions:

- Fuzzy or unclear focus
- Ghosting, streaking or shadowing effects
- Faint vertical bars
- Thin, horizontal scrolling lines
- An off-center picture



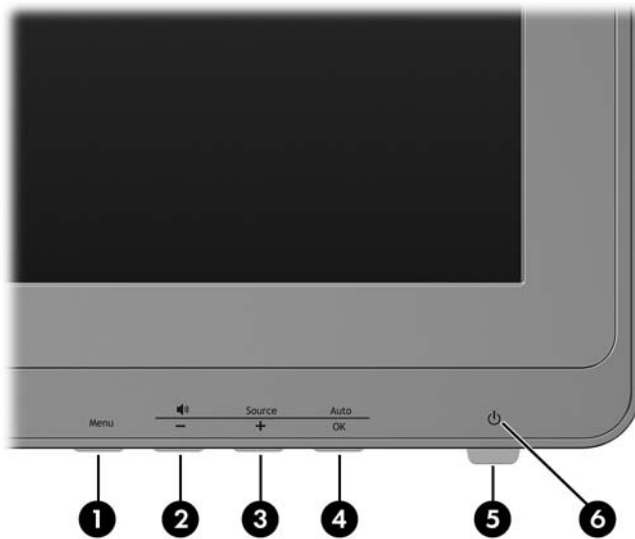

To use the auto-adjustment feature:

1. Allow the monitor to warm up for 20 minutes before adjusting.
2. Press the [Auto/OK](#) button on the monitor front panel.
  - You can also press the [Menu](#) button, then select **Image Control > Auto-Adjustment** from the OSD Main Menu. Refer to [Adjusting the Monitor Settings on page 21](#) in this chapter.
  - If the result is not satisfactory, continue with the procedure.
3. Insert the CD in the disc drive. The CD menu is displayed.
4. Select **Open Auto-Adjustment Software**. The setup test pattern is displayed.
5. Press the [Auto/OK](#) button on the monitor front panel to produce a stable, centered image.
6. Press the [ESC](#) key or any other key on the keyboard to exit the test pattern.

## Front Panel Controls



**Table 4-2** Monitor Front Panel Controls

No.	Icon	Control	Function
1	Menu	Menu	Opens, selects or exits the OSD menu.
2		Volume/Minus	If the OSD menu is inactive, press to open the Volume adjustment OSD sub-menu.  If the OSD menu is on, press to navigate down through the OSD menu and decrease adjustment levels.
3		Source/Plus	If the OSD menu is inactive, press to activate the source button that chooses the video signal input.  If the OSD menu is on, press to navigate up through the OSD menu and increase adjustment levels.
4		Auto/OK	If the OSD menu is inactive, press to activate the auto adjustment feature to optimize the screen image.  If the OSD menu is on, press to select the highlighted menu item.
5		Power	Turns the monitor on or off as long as the master power switch on the rear panel is on.
6		Power LED	AquaWhite = Fully powered.  Amber = Sleep mode.  Flashing Amber = Sleep Timer mode.

# Adjusting the Monitor Settings

The monitor settings can be adjusted from the On-Screen Display (OSD) menu.

 **NOTE:** If there is a problem with the display settings, try resetting the settings to the factory defaults by opening the OSD and selecting **Factory Reset** from the OSD menu.

## Using the On-Screen Display Menu

Use the On-Screen Display (OSD) to adjust the screen image based on your viewing preferences. To access the OSD, do the following:

1. If the monitor is not already on, press the **Power** button to turn on the monitor.
2. To access the OSD Menu, press the **Menu** button on the monitor's front panel.



3. To navigate through the OSD Menu, press the **+** (Plus) button on the monitor's front panel to scroll up, or the **-** (Minus) button to scroll down.
4. To select an item from the OSD Menu, use the **+** or **-** buttons to scroll to and highlight your selection, then press the **OK** button to select that function.
5. Adjust the item using the **+** or **-** buttons on the front panel to adjust the scale.
6. After adjusting the function, select **Save and Return**, or **Cancel** if you don't want to save the setting, then select **Exit** from the Main Menu.

 **NOTE:** If the buttons remain untouched for 30 seconds (factory default) while displaying a menu, the firmware will save the current adjustments and exit. Also, if the video controller changes video mode while the OSD is active, the current (adjusted) settings will not be saved, the OSD will be turned off, and the new mode will be displayed.







## OSD Menu Selections

The following table lists the On-Screen Display (OSD) menu selections and their functional descriptions. After changing an OSD menu item, and if the menu screen has these options, you may choose to:















- **Cancel**—to return to the previous menu level.
- **Save and Return**—to save all changes and return to the OSD Main Menu screen. This Save and Return option is only active if you change a menu item.

 **NOTE:** Depending on how your system is configured, some of the menu items listed below may not be available for use.







**Table 4-3 OSD Menu**

Icon	Main Menu	Submenu	Description
	Brightness	Adjustable scale	Adjusts the brightness level of the screen. The factory default range is 90.
	Contrast	Adjustable scale	Adjusts the contrast level of the screen. The factory default range is 80.
	Color		Selects the screen color. The factory default is 6500K or Custom Color, depending on the model.
		9300 K	Changes to slightly blueish white.
		6500 K	Changes to slightly reddish white.
		sRGB	Sets your screen colors to adapt to the color standards used in the image technology industry.
		Quick View	Select from the following viewing modes: <ul style="list-style-type: none"> <li>• Movie</li> <li>• Photo</li> <li>• Gaming</li> <li>• Text</li> <li>• Custom (settings saved when you adjust the Brightness, Contrast, or Color in one of the other Quick View options)</li> </ul>
		Custom Color	Selects and adjusts your own color scales: <ul style="list-style-type: none"> <li>• R—sets your own red color levels</li> <li>• G—sets your own green color levels</li> <li>• B—sets your own blue color levels</li> </ul>
		Reset	Resets the Color menu to the Factory default 6500K setting, and resets Quick View to the default Text option. It will not reset or affect Custom Color RGB settings.
	Image Control		Adjusts the screen image (VGA input only).
		Auto Adjustment	Automatically adjusts the screen image (VGA input only).

**Table 4-3 OSD Menu (continued)**







Icon	Main Menu	Submenu	Description
		Clock	Minimizes any vertical bars or strips visible on the screen background (VGA input only). Adjusting the Clock will also change the horizontal screen image.
		Clock Phase	Adjusts the focus of the display (VGA input only). This adjustment allows you to remove any horizontal noise and clear or sharpen the image of characters.
		Horizontal Position	Adjusts the position of the screen image left and right (VGA input only).
		Vertical Position	Adjusts the position of the screen image up and down (VGA input only).
		Custom Scaling	Selects the method on how displayed information on the monitor will be formatted. Select: <ul style="list-style-type: none"> <li>• Fill to Screen - image fills the entire screen and may look distorted or elongated because of non-proportional scaling of height and width</li> <li>• Fill to Aspect Ratio - image is sized to fit the screen and maintains proportional image</li> </ul>
		Sharpness	Adjusts the screen image to look sharper or soft.
		Video Overdrive	Turns Video Overdrive On or Off. The factory default is Off.
		Dynamic Contrast Ratio	Turns Dynamic Contrast Ratio (DCR) On or Off. The factory default is Off.
	OSD Control		Provides a menu for adjusting the on-screen display (OSD) controls.
		Horizontal OSD Position	Changes the viewing position of the OSD menu to the left or right area of the screen. The factory default range is 50.
		Vertical OSD Position	Changes the viewing position of the OSD menu to the top or bottom area of the screen. The factory default range is 50.
		OSD Transparency	Adjust to view the background information through the OSD.
		OSD Timeout	Sets the time duration in seconds that the OSD is visible after the last button is pressed. The range is 5 – 60 seconds. The factory default is 30 seconds.
	Management		Selects the OSD and power management features of the monitor.
		Power Saver	Enables the power saving feature. Select: <ul style="list-style-type: none"> <li>• On</li> <li>• Off</li> </ul> <p>The factory default is On.</p>

**Table 4-3 OSD Menu (continued)**



Icon	Main Menu	Submenu	Description
		Power On Recall	Restores power to the monitor following an unexpected removal of power. Select: <ul style="list-style-type: none"> <li>• On</li> <li>• Off</li> </ul> <p>The factory default is On.</p>
		Mode Display	Displays the resolution, refresh rate and frequency information on the screen each time the OSD Main Menu is accessed. Select: <ul style="list-style-type: none"> <li>• On</li> <li>• Off</li> </ul> <p>The factory default is On.</p>
		Monitor Status Display	Displays the operating status of the monitor each time the monitor is powered on. Select the location to display the status to: <ul style="list-style-type: none"> <li>• Top</li> <li>• Middle</li> <li>• Bottom</li> <li>• Off</li> </ul> <p>The factory default is Top.</p>
		DDC/CI Support	Allows the computer to control some OSD menu features such as brightness, contrast and color temperature. Set to: <ul style="list-style-type: none"> <li>• On</li> <li>• Off</li> </ul> <p>The factory default is On.</p>
		Bezel Power LED	Turns off the power LED on the front panel of the monitor. The factory default is On.
		Volume	Provides volume adjustment menu options: <ul style="list-style-type: none"> <li>• Adjustable scale for the volume of the monitor speakers. The range is 0 – 100. The default setting is 90.</li> <li>• Select Audio Auto-Detect – Allows the monitor to automatically detect either PC or HDMI audio source (2310t models only).</li> <li>• Select HDMI Audio – Allows you to manually select the HDMI audio source (2310t models only).</li> <li>• Select PC Audio – Allows you to manually select the PC audio source (2310t models only).</li> <li>• Speaker Self-Test – Tests the functionality of the speaker.</li> </ul>



**Table 4-3 OSD Menu (continued)**

Icon	Main Menu	Submenu	Description
		Sleep Timer	Provides the timer adjustment menu options: <ul style="list-style-type: none"> <li>• Set Current Time—sets the current time in hours and minutes</li> <li>• Set Sleep Time—sets the time you want to place the monitor in sleep mode</li> <li>• Set on Time—sets the time you want the monitor to wake up from sleep mode</li> <li>• Timer—sets the Sleep Timer feature On or Off. The default setting is Off.</li> <li>• Sleep Now—immediately sets the monitor to enter sleep mode</li> </ul>
	Language		Selects the language in which the OSD menu is displayed. The factory default is English.
	Information		Selects and displays important information about the monitor.
		Current Settings	Provides the current input video mode.
		Recommended Settings	Provides the recommended resolution mode and refresh rate for the monitor.
		Serial Number	Reports the serial number of the monitor. The serial number is needed if contacting HP technical support.
		FW Version	Reports the firmware version of the monitor.
		Backlight Hours	Reports the total hours of backlight operation.
		Service Support	<a href="http://www.hp.com/support">http://www.hp.com/support</a>
	Factory Reset		Returns all OSD menu settings and DDC/CI controls to the factory default settings, except the Language.
	Source Control		Selects the video input signal. DVI is the factory default.
		DVI	Selects DVI as the video input signal.
		HDMI (2310t models only)	Selects HDMI as the video input signal.
		VGA (2310ti models only)	Selects VGA as the video input signal.
		Default Source	Selects the default or primary video input signal when the monitor is connected to two active and valid video sources. The monitor will automatically determine the video format. The choices are: <ul style="list-style-type: none"> <li>• DVI</li> <li>• HDMI (2310t models only)</li> <li>• VGA (2310ti models only)</li> </ul> The factory default is DVI.

**Table 4-3 OSD Menu (continued)**

Icon	Main Menu	Submenu	Description
		Auto-Switch Source	Turns the system's automatic video signal input to On or Off. The factory default is On.
	Exit		Exits the OSD menu screen.

## Optimizing Digital Conversion

Two controls in the on-screen display can be adjusted to improve image performance: Clock and Clock Phase.

 **NOTE:** The Clock and Clock Phase controls are adjustable only when using an analog input. These controls are not adjustable for digital inputs.

The Clock must first be set correctly since the Clock Phase settings are dependent on the main Clock setting. Use these controls only when the auto-adjustment function does not provide a satisfactory image.

- **Clock**—Increases/decreases the value to minimize any vertical bars or stripes visible on the screen background.
- **Clock Phase**—Increases/decreases the value to minimize video distortion or video jitter.

 **NOTE:** When using the controls, you will obtain the best results by using the auto-adjustment pattern software utility provided on the CD.

When adjusting the Clock and Clock Phase values, if the monitor images become distorted, continue adjusting the values until the distortion disappears. To restore the factory settings, select Yes from the Factory Reset menu in the on-screen display.

# Identifying Monitor Conditions

Special messages will appear on the monitor screen when identifying the following monitor conditions:

- **Monitor Status**—When the monitor is powered on or when the input source signal is changed, a Monitor Status message is displayed for five seconds. The message shows which input is the current active signal, the status of the auto-switch source setting (On or Off), the default source signal, the current preset display resolution, and the recommended preset display resolution.
- **Input Signal Out of Range—Change resolution setting to 1920 x 1080 – 60Hz**—Indicates the monitor does not support the input signal because the resolution and/or refresh rate are set higher than the monitor supports.
- **No Source Signal**—Indicates the monitor is not receiving a video signal from the PC on the monitor video input connector. Check to determine if the PC or input signal source is off or in the power saving mode.
- **Auto Adjustment in Progress**—Indicates the auto-adjustment function is active.
- **Monitor Going to Sleep**—Indicates the screen display is entering a sleep mode.
- **Check Video Cable**—Indicates the video cable is not properly connected to the computer.
- **OSD Lockout**—The OSD can be enabled or disabled by pressing and holding the **Menu** button on the front panel for 10 seconds. If the OSD is locked, the warning message **OSD Lockout** displays for ten seconds.
  - If the OSD is locked, press and hold the **Menu** button for 10 seconds to unlock the OSD.
  - If the OSD is unlocked, press and hold the **Menu** button for 10 seconds to lock the OSD.
- **Power Button Lockout**—Indicates the power button is locked. If the power button is locked, the warning message **Power Button Lockout** displays.
  - If the power button is locked, press and hold the power button for 10 seconds to unlock the power button function.
  - If the power button is unlocked, press and hold the power button for 10 seconds to lock out the power button function.
- **Dynamic Contrast Ratio On**—Indicates that Dynamic Contrast Ratio has been turned on. This occurs if Dynamic Contrast Ratio is turned on in the **Image Control** OSD menu or if Movie mode is selected from the Quick View sub-menu in the OSD.
- **Dynamic Contrast Ratio Off**—Indicates that Dynamic Contrast Ratio has been turned off. This occurs if Dynamic Contrast Ratio is turned off in the **Image Control** OSD menu or if Movie mode is changed to another viewing mode in the Quick View OSD sub-menu.
- **Settings Saved as Custom**—Indicates that a Custom setting has been saved in the Quick View sub-menu. This occurs if a preset is selected in the Quick View menu then the Brightness, Contrast, or Color is also changed in the OSD.
- **Speaker Self-Test In Progress**—Indicates the monitor is testing the left and right speakers.

## Sleep Timer Mode

The Sleep Timer mode is an energy-saving feature that enables you to set a time for the monitor to power on and off at the same time every day. This also extends the life of the backlight bulbs in the monitor. The Sleep Timer has five settings:

- Set Current Time
- Set Sleep Time
- Set On Time
- Timer: On/Off
- Sleep Now

To set the timer:

1. Press the **Menu** button on the monitor front panel to display the **OSD Menu**.
2. Scroll down and highlight **Management**.
3. Press the **OK** button to select **Management**.
4. Scroll down and highlight and select **Sleep Timer > Set Current Time**.

---

 **NOTE:** You must set the current local time before you reset the time for **Sleep Time** or **On Time**. Note that the time is displayed in a 24-hour clock format. For example, 1:15 p.m. is displayed as 13 hours 15 minutes.

A power failure or loss of power to the monitor will cause the timer to reset to 00:00. If this occurs, you will need to reset the sleep timer mode.

---

5. Press the **OK** button once to enter the adjustment mode for hours.
6. Press the **-** (Minus) or **+** (Plus) button to adjust the hour.
7. Press the **OK** button again to enter the time for minutes.
8. Press the **-** (Minus) or **+** (Plus) button to adjust the minutes.
9. Press the **OK** button to lock in the time chosen.
10. After setting the current time, the highlight automatically skips to **Set Sleep Time**. Repeat steps 6 through 9 to set **Sleep Time**.
11. If you do not want to set **Sleep Time**, press the **OK** button twice, then select **Save and Return** to exit the menu.
12. After setting **Sleep Time**, the highlight automatically skips to **Set On Time**. Repeat steps 6 through 9 to set **On Time**.
13. Set the **Timer mode** to **On** to activate the **Sleep Timer** settings.
14. When you are finished, select **Save and Return** to exit the menu.

The fifth selection, **Sleep Now**, turns the monitor backlights off immediately and stays in sleep mode until the next **On Time** activates or a monitor button is pressed.

# sRGB Support

The monitor is designed to support sRGB for color management, which adapts to the color standards used in the image technology industry.

To take advantage of the sRGB support, you will need to change the monitor's color temperature to Standard and install the sRGB color profile (ICM) file.

---

 **NOTE:** The sRGB color temperature preset will improve the color accuracy of sRGB images on the computer monitor, but some color variation may still occur.

---

## Changing the Color Temperature

1. Press the **Menu** button on the front panel of the monitor to launch the **Main Menu** of the OSD.
2. Select **Color**.
3. Select **sRGB**.
4. Select **Save and Return** to exit the menu.

## Installing the sRGB ICM File for Microsoft Windows 2000 and Windows XP

---

 **NOTE:** To complete the following procedure, you must be logged in as an administrator or a member of the administrator's group. If the computer is connected to a network, network policy settings may prevent you from completing this procedure. The sRGB ICM file does not support Windows 95 and Windows NT operating systems.

---

1. Click the **Display** icon in the Control Panel.
2. In the **Display Properties** windows, select the **Settings** tab, then click the **Advanced** button.
3. Select the **Color Management** tab, then click the **Add** button to open the **Add Profile Association** dialog box.
4. Select the **sRGB Color Space Profile.icm** file, then click the **Add** button
5. To activate a color profile for the monitor, you must set it as the Default Monitor Profile. Select **sRGB Color Space Profile**, then click **Set as Default** button.
6. Click **Apply** or **OK**.

## Installing the sRGB ICM File for Microsoft Windows Vista

1. Click **Appearance and Personalization** icon in the Control Panel.
2. Click **Personalization**.
3. Click **Display Settings**.
4. Click the **Advanced Settings** button.
5. Click the **Color Management** tab, then click the **Color Management** button.
6. Click the **Advanced** tab, then click the **Change System Defaults** button.
7. On the **Devices** tab, click the **Add** button.
8. Select the **RGB Color Space Profile.icm** file, then click the **OK** button.
9. To activate a color profile for the monitor, you must set it as the Default Monitor Profile. Select **sRGB Color Space Profile**, then click the **Set as Default** button.

## Installing the sRGB ICM File for Microsoft Windows 7

1. Click **Appearance and Personalization** icon in the Control Panel.
2. Click **Display**.
3. Click **Change display settings**.
4. Click **Advanced settings**.
5. Click the **Color Management** tab, then click the **Color Management** button.
6. Click the **Advanced** tab, then click the **Change System Defaults** button.
7. On the **Devices** tab, click the **Add** button.
8. Select the **RGB Color Space Profile.icm** file, then click the **OK** button.
9. To activate a color profile for the monitor, you must set it as the Default Monitor Profile. Select **sRGB Color Space Profile**, then click the **Set as Default** button.

# A Troubleshooting

## Solving Common Problems

The following table lists possible problems, the possible cause of each problem, and the recommended solutions.

Problem	Possible Cause	Solution
Power LED is not on.	Power is not on.	Ensure that the power cord is properly connected to a grounded power outlet and to the monitor, and the monitor power button is on.
	Bezel power LED is turned off in the OSD.	Press the <a href="#">Menu</a> button to open the OSD and select <a href="#">Management &gt; Bezel Power LED</a> , then set it to <a href="#">On</a> mode.
Screen is blank.	Power cord is disconnected.	Connect the power cord.
	Power button on front panel of the monitor is turned off.	Press the front panel power button. <b>NOTE:</b> If pressing the power button has no effect, press and hold the power button for 10 seconds to disable the power button lockout feature.
	Video cable is improperly connected.	Connect the video cable properly. Refer to Chapter 3, <a href="#">Setting Up the Monitor on page 4</a> for more information.
	Screen blanking is active.	Press any key on the keyboard or move the mouse to inactivate the screen blanking utility.
Touch function is not working.	USB cable is not connected.	Connect the provided USB cable between the monitor and computer.
	Touch driver is not installed (Windows XP only).	If your system is running Windows XP, install the touch driver from the CD provided.
Screen image appears distorted; text is fuzzy or blurred; image quality is degraded.	The computer's graphics card resolution is set lower or higher than the monitor's native resolution.	Set the computer's display resolution to the same mode as the monitor's recommended native screen resolution to provide the best picture quality.
Image appears blurred, indistinct, or too dark.	Brightness and contrast are too low.	Press the <a href="#">Auto/OK</a> button on the front panel. If this does not correct the image, press the <a href="#">Menu</a> button to open the OSD Menu, and adjust the brightness and contrast scales as needed.
Picture bounces, flickers, or wave pattern is present in the picture.	Interference from another electrical device.	Move electrical devices that may cause electrical interference as far away from the monitor as possible.
Image is not centered	Position may need adjustment.	Press the <a href="#">Menu</a> button to access the OSD menu. Select <a href="#">Image Control/Horizontal Position</a> or <a href="#">Vertical Position</a> to adjust the horizontal or vertical position of the image.

Problem	Possible Cause	Solution
<b>Check Video Cable</b> is displayed on screen.	Monitor video cable is disconnected.	Connect the appropriate video cable (HDMI, DVI, or VGA) between the computer and monitor. Be sure that the computer power is off while connecting the video cable.
<b>Input Signal Out of Range. Change Settings to 1920 × 1080 @ 60Hz</b> is displayed on screen.	Video resolution and/or refresh rate are set higher than what the monitor supports.	Restart the computer and enter Safe Mode. Change the settings to a supported setting (see <a href="#">Recognizing Preset Display Resolutions on page 35</a> ). Restart the computer so that the new settings take effect.
The monitor is off but it did not seem to enter into a low-power sleep mode.	The monitor's power saving control is disabled.	In the monitor's OSD menu, select <b>Management &gt; Power Saver</b> . The control should be set to <b>On</b> to allow the monitor to enter into low-power modes.
Using HDMI connection, unable to hear audio.	Computer is not configured for HDMI audio.	Ensure HDMI audio is selected as the main audio output in the operating system. To do so, click the <a href="#">Windows Start Button</a> , and then click <a href="#">Control Panel</a> . Click <a href="#">Sound</a> , and in the Playback tab, ensure the check mark is next to the HDMI output, and click <a href="#">OK</a> .
	HDMI audio is not selected in the monitor OSD.	Press the <a href="#">Menu</a> button to open the OSD and select <a href="#">Volume</a> , then choose either <a href="#">Select HDMI Audio</a> or <a href="#">Select Audio Auto-Detect</a> .
Unable to hear audio from built-in speakers.	Volume is muted or too low.	Do the following: <ul style="list-style-type: none"> <li>• Ensure the source signal is good by using headphones at the source.</li> <li>• Press the <a href="#">Menu</a> button to access the OSD menu. Select <a href="#">Management</a>, and then select <a href="#">Volume</a> to adjust the volume.</li> <li>• Turn up the volume with the front panel volume button.</li> <li>• Ensure speaker volume is not muted or too low: Click the <a href="#">Windows Start Button</a>, <a href="#">Control Panel</a>, and <a href="#">Hardware and Sound</a>. Under <a href="#">Sound</a>, click <a href="#">Adjust system volume</a>. Under <a href="#">Speakers</a>, move the slider up.</li> </ul>
<b>OSD Lockout</b> is displayed.	The monitor's OSD Lockout function is enabled.	Press and hold the <a href="#">Menu</a> button for 10 seconds to disable the OSD Lockout function.
<b>Power Button Lockout</b> is displayed.	The monitor's Power Button Lockout function is enabled.	Press and hold the <a href="#">Power</a> button for 10 seconds to unlock the power button function.



## Online Technical Support

For the online access to technical support information, self-solve tools, online assistance, community forums of IT experts, broad multivendor knowledge base, monitoring and diagnostic tools, go to <http://www.hp.com/support>

## Preparing to Call Technical Support

If you cannot solve a problem using the troubleshooting tips in this section, you may need to call technical support. Have the following information available when you call:

- Monitor model number
- Monitor serial number
- Purchase date on invoice
- Conditions under which the problem occurred
- Error messages received
- Hardware configuration
- Name and version of the hardware and software you are using

## B Technical Specifications

 **NOTE:** All performance specifications are provided by the component manufacturers. Performance specifications represent the highest specification of all HP's component manufacturers' typical level specifications for performance and actual performance may vary either higher or lower.

### 2310t and 2310ti Models

**Table B-1 2310t and 2310ti Specifications**

Display	58.42 cm wide screen	23 inches wide screen
Type	TFT LCD	
Viewable Image Size	58.42 cm diagonal	23-inch diagonal
Tilt	-5° to +55°	
Maximum Weight (Unpacked)	8.2 kg	18.1 lbs.
Dimensions (include base)		
Height	38.9 cm	15.3 inches
Depth	19.9 cm	7.8 inches
Width	57.3 cm	22.6 inches
Maximum Graphic Resolution	1920 x 1080 (60 Hz) analog input 1920 x 1080 (60 Hz) digital input	
Optimum Graphic Resolution	1920 x 1080 (60 Hz) analog input 1920 x 1080 (60 Hz) digital input	
Text Mode	720 × 400	
Dot Pitch	0.265 (H) × 0.265 (W) mm	
Pixels Per Inch	95.7 PPI	
Horizontal Frequency	24 to 94 kHz	
Vertical Refresh Rate	50 to 76 Hz	
Environmental Requirements Temperature		
Operating Temperature	5 to 35° C	41 to 95° F
Storage Temperature	-20 to 60° C	-4 to 140° F
Relative Humidity	20 to 80%	
Power Source	100 – 240 VAC, 50/60 Hz	
Altitude:		
Operating	0 to 5,000 m	0 to 16,400 feet
Storage	0 to 12192 m	0 to 40,000 feet

**Table B-1 2310t and 2310ti Specifications (continued)**

Measured Power Consumption	
Full Power	56 watts
Typical Settings	47 watts
Sleep	2 watts
Bezel Switch Off	1 watts
Input Terminal	One DVI connector with cable included (2310t and 2310ti models); one HDMI connector with cable not included (2310t model only); one VGA connector with cable not included (2310ti model only)

## Recognizing Preset Display Resolutions

The display resolutions listed below are the most commonly used modes and are set as factory defaults. This monitor automatically recognizes these preset modes and they will appear properly sized and centered on the screen.

### 2310t and 2310ti Factory Preset Display Modes

**Table B-2 Factory Preset Modes**

Preset	Pixel Format	Horz Freq (kHz)	Vert Freq (Hz)
1	640 × 480	31.469	59.940
2	720 × 400	31.469	70.087
3	800 × 600	37.879	60.317
4	1024 × 768	48.363	60.004
5	1280 × 720	45.00	60.00
6	1280 × 960	60.00	60.00
7	1280 × 1024	63.98	60.02
8	1440 × 900	55.94	59.89
9	1600 × 1200	75.00	60.00
10	1680 × 1050	65.29	60.00
11	1920 × 1080	67.50	60.00

### 2310t High Definition Video Formats

When the monitor is operating in the video mode (not displaying data) using the HDMI connector, the following high definition modes are supported in addition to standard definition video.

Preset	Timing Name	Pixel Format	Horz Freq (kHz)	Vert Freq (Hz)
1	480p	720 × 480	31.469	60
2	720p60	1280 × 720	45	60

3	576p	720 × 576	31.25	50
4	720p50	1280 × 720	37.5	50
5	1080p60	1920 × 1080	67.5	60
6	1080p50	1920 × 1080	56.25	50

## Entering User Modes

The video controller signal may occasionally call for a mode that is not preset if:

- You are not using a standard graphics adapter.
- You are not using a preset mode.

If this occurs, you may need to readjust the parameters of the monitor screen by using the on-screen display. Your changes can be made to any or all of these modes and saved in memory. The monitor automatically stores the new setting, then recognizes the new mode just as it does a preset mode. In addition to the factory preset modes, there are at least twenty user modes that can be entered and stored.

## Energy Saver Feature

When the monitor is in its normal operating mode, the monitor uses less than 47 watts and the Power light is AquaWhite.

The monitor also supports a reduced power state. The reduced power state will be entered into if the monitor detects the absence of either the horizontal sync signal and/or the vertical sync signal. Upon detecting the absence of these signals, the monitor screen is blanked, the backlight is turned off, and the power light is turned amber. When the monitor is in the reduced power state, the monitor will utilize less than 2 watts of power. There is a brief warm up period before the monitor will return to its normal operating mode.

Refer to the computer manual for instructions on setting energy saver features (sometimes called power management features).

 **NOTE:** The above power saver feature only works when connected to computers that have energy saver features.

By selecting the settings in the monitor's Energy Saver utility, you can also program the monitor to enter into the reduced power state at a predetermined time. When the monitor's Energy Saver utility causes the monitor to enter the reduced power state, the power light blinks amber.

---

# C Agency Regulatory Notices

## Federal Communications Commission Notice

This equipment has been tested and found to comply with the limits for a Class B digital device, pursuant to Part 15 of the FCC Rules. These limits are designed to provide reasonable protection against harmful interference in a residential installation. This equipment generates, uses, and can radiate radio frequency energy and, if not installed and used in accordance with the instructions, may cause harmful interference to radio communications. However, there is no guarantee that interference will not occur in a particular installation. If this equipment does cause harmful interference to radio or television reception, which can be determined by turning the equipment off and on, the user is encouraged to try to correct the interference by one or more of the following measures:

- Reorient or relocate the receiving antenna.
- Increase the separation between the equipment and the receiver.
- Connect the equipment into an outlet on a circuit different from that to which the receiver is connected.
- Consult the dealer or an experienced radio or television technician for help.

## Modifications

The FCC requires the user to be notified that any changes or modifications made to this device that are not expressly approved by Hewlett Packard Company may void the user's authority to operate the equipment.

## Cables

Connections to this device must be made with shielded cables with metallic RFI/EMI connector hoods to maintain compliance with FCC Rules and Regulations.

## Declaration of Conformity for Products Marked with the FCC Logo (United States Only)

This device complies with Part 15 of the FCC Rules. Operation is subject to the following two conditions:

1. This device may not cause harmful interference.
2. This device must accept any interference received, including interference that may cause undesired operation.

For questions regarding the product, contact:

Hewlett Packard Company

P. O. Box 692000, Mail Stop 530113

Houston, Texas 77269-2000

Or, call 1-800-HP-INVENT (1-800 474-6836)

For questions regarding this FCC declaration, contact:

Hewlett Packard Company

P. O. Box 692000, Mail Stop 510101

Houston, Texas 77269-2000

Or, call (281) 514-3333

To identify this product, refer to the Part, Series, or Model number found on the product.

## Canadian Notice

This Class B digital apparatus meets all requirements of the Canadian Interference-Causing Equipment Regulations.

## Avis Canadien

Cet appareil numérique de la classe B respecte toutes les exigences du Règlement sur le matériel brouilleur du Canada.

## European Union Regulatory Notice

This product complies with the following EU Directives:

- Low Voltage Directive 2006/95/EC
- EMC Directive 2004/108/EC
- EuP Directive 2005/32/EC, where applicable

Compliance with these directives implies conformity to applicable harmonized European standards (European Norms) which are listed on the EU Declaration of Conformity issued by Hewlett-Packard for this product or product family.

This compliance is indicated by the following conformity marking placed on the product:

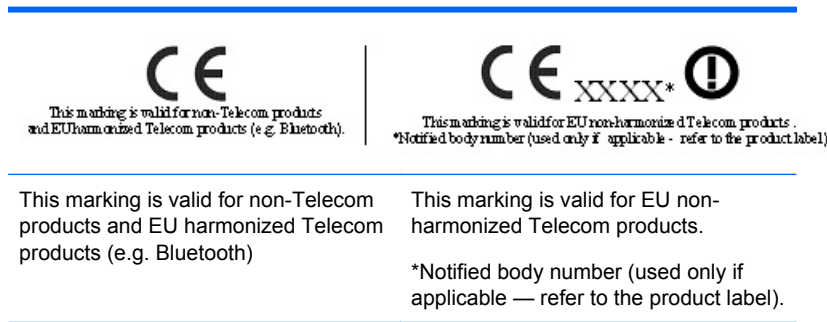

Hewlett-Packard GmbH, HQ-TRE, Herrenberger Strasse 140, 71034 Boeblingen, Germany

The official EU CE declaration of conformity for this device may be found at <http://www.hp.com/go/certificates>.

## German Ergonomics Notice

HP products which bear the “GS” approval mark, when forming part of a system comprising HP brand computers, keyboards and monitors that bear the “GS” approval mark, meet the applicable ergonomic requirements. The installation guides included with the products provide configuration information.

## Japanese Notice

この装置は、クラスB情報技術装置です。この装置は、家庭環境で使用することを目的としていますが、この装置がラジオやテレビジョン受信機に近接して使用されると、受信障害を引き起こすことがあります。取扱説明書に従って正しい取り扱いをして下さい。

VCCI-B

## Korean Notice

B급 기기  
(가정용 방송통신기기)

이 기기는 가정용(B급)으로 전자파적합등록을 한 기기로서 주로 가정에서 사용하는 것을 목적으로 하며, 모든 지역에서 사용할 수 있습니다.

## Power Cord Set Requirements

The monitor power supply is provided with Automatic Line Switching (ALS). This feature allows the monitor to operate on input voltages between 100–120V or 200–240V.

The power cord set (flexible cord or wall plug) received with the monitor meets the requirements for use in the country where you purchased the equipment.

If you need to obtain a power cord for a different country, you should purchase a power cord that is approved for use in that country.

The power cord must be rated for the product and for the voltage and current marked on the product's electrical ratings label. The voltage and current rating of the cord should be greater than the voltage and current rating marked on the product. In addition, the cross-sectional area of the wire must be a minimum of 0.75 mm<sup>2</sup> or 18 AWG, and the length of the cord must be between 6 feet (1.8 m) and 12 feet (3.6 m). If you have questions about the type of power cord to use, contact an authorized HP service provider.

A power cord should be routed so that it is not likely to be walked on or pinched by items placed upon it or against it. Particular attention should be paid to the plug, electrical outlet, and the point where the cord exits from the product.

## Japanese Power Cord Requirements

For use in Japan, use only the power cord received with this product.

△ **CAUTION:** Do not use the power cord received with this product on any other products.

# Product Environmental Notices

## Materials Disposal

This HP product contains mercury in the fluorescent lamp in the display LCD that might require special handling at end-of-life.

Disposal of this material can be regulated because of environmental considerations. For disposal or recycling information, contact the local authorities or the Electronic Industries Alliance (EIA) <http://www.eiae.org>.

## Disposal of Waste Equipment by Users in Private Household in the European Union



This symbol on the product or on its packaging indicates that this product must not be disposed of with your household waste. Instead, it is your responsibility to dispose of your waste equipment by handing it over to a designated collection point for the recycling or waste electrical and electronic equipment. The separate collection and recycling of your waste equipment at the time of disposal will help to conserve natural resources and ensure that it is recycled in a manner that protects human health and the environment. For more information about where you can drop off your waste equipment for recycling, please contact the local city office, the household waste disposal service or the shop where you purchased the product.

## HP Recycling Program

HP encourages customers to recycle used electronic hardware, HP original print cartridges, and rechargeable batteries. For more information about recycling programs, go to <http://www.hp.com/recycle>.

## Chemical Substances

HP is committed to providing our customers with information about the chemical substances in our products as needed to comply with legal requirements such as REACH (Regulation EC No 1907/2006 of the European Parliament and Council). A chemical information report for this product can be found at <http://www.hp.com/go/reach>.

## Restriction of Hazardous Substances (RoHS)

A Japanese regulatory requirement, defined by specification JIS C 0950, 2005, mandates that manufacturers provide Material Content Declarations for certain categories of electronic products offered for sale after July 1, 2006. To view the JIS C 0950 material declaration for this product, visit <http://www.hp.com/go/jisc0950>.



## 有毒有害物质/元素的名称及含量表

根据中国  
《电子信息产品污染控制管理办法》

### 液晶显示器

部件名称	有毒有害物质和元素					
	铅 (Pb)	汞 (Hg)	镉 (Cd)	六价铬 (Cr(VI))	多溴联苯 (PBB)	多溴二苯醚 (PBDE)
液晶显示器显示面板	X	X	○	○	○	○
机箱/其它	X	○	○	○	○	○

### CRT 显示器

部件名称	有毒有害物质和元素					
	铅 (Pb)	汞 (Hg)	镉 (Cd)	六价铬 (Cr(VI))	多溴联苯 (PBB)	多溴二苯醚 (PBDE)
阴极射线管	X	○	○	○	○	○
机箱/其它	X	○	○	○	○	○

O: 表示该有毒或有害物质在该部件所有均质材料中的含量均在 SJ/T11363-2006 标准规定的限量要求以下。

X: 表示该有毒或有害物质至少在该部件所用的某一均质材料中的含量超出 SJ/T11363-2006 标准规定的限量要求。

表中标有“X”的所有部件都符合欧盟 RoHS 法规 — “欧洲议会和欧盟理事会 2003 年 1 月 27 日关于电子电器设备中限制使用某些有害物质的 2002/95/EC 号指令”。

注: 环保使用期限的参考标识取决于产品正常工作的温度和湿度等条件。

## Turkey EEE Regulation

In Conformity with the EEE Regulation

EEE Yönetmeliğine Uygundur

---

## D LCD Monitor Quality and Pixel Policy

The TFT monitor uses high-precision technology, manufactured according to HP standards, to guarantee trouble-free performance. Nevertheless, the display may have cosmetic imperfections that appear as small bright or dark spots. This is common to all LCD displays used in products supplied by all vendors and is not specific to the HP LCD. These imperfections are caused by one or more defective pixels or sub-pixels.

- A pixel consists of one red, one green, and one blue sub-pixel.
- A defective whole pixel is always turned on (a bright spot on a dark background), or it is always off (a dark spot on a bright background). The first is the more visible of the two.
- A defective sub-pixel (dot defect) is less visible than a defective whole pixel and is small and only visible on a specific background.

To locate defective pixels, the monitor should be viewed under normal operating conditions, in normal operating mode at a supported resolution and refresh rate, from a distance of approximately 50 cm (20 in).

HP expects that, over time, the industry will continue to improve its ability to produce LCDs with fewer cosmetic imperfections and HP will adjust guidelines as improvements are made.